



Investor Meeting in US

July 2001

Tsugio Yamamoto

President and Representative Director

Minebea Co., Ltd.

Second Year of the Three-Year Management Plan

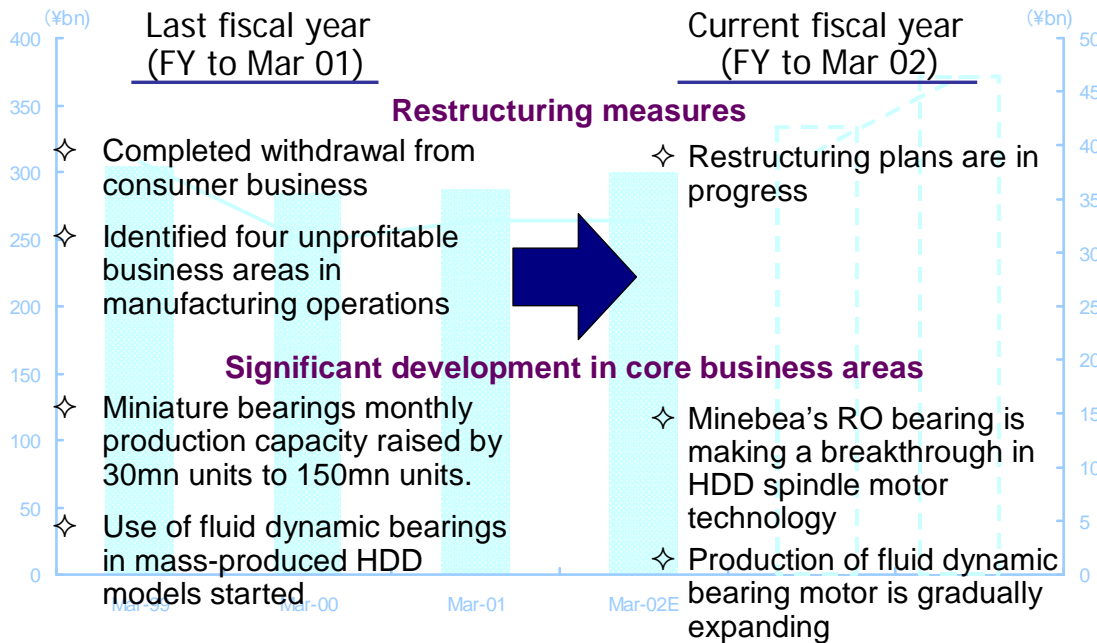

We launched the three-year management plan in May 2000

July, 2001



Last fiscal year marked a milestone in the sense that it was the first year of the company's three-year management plan. During this fiscal year, we intend to continue with strategies and directions we set forth a year ago and work towards the goals. During last fiscal year, we sold Actus, a furniture import and sales company, thereby making a complete withdrawal from the consumer business - a task we had set ourselves since 1993. Also in the manufacturing operations, we reassessed four business areas that are loss making or are limited in growth potential. In the current fiscal year we intend to continue with the restructuring measures and execute plans to either withdraw from or turn around these loss making operations. Meanwhile, in the area of HDD spindle motor business, where we have been putting extra emphasis on for some years, our own RO bearing is making a new breakthrough in HDD spindle motor technology, while use of fluid dynamic bearings in mass-produced HDD models has begun. All these strategies abide by the three-year management plan and directions.

Three Basic Management Directions to become a High-Growth, Highly Profitable Company

1. To increase production of most profitable mainstay bearings and bearing-related products;
2. To expand small motors and other rotary components business to a scale similar to bearing operation; and
3. To raise the weight of high-value-added products in main product categories.

Realization

Minebea's Basis of Strength

“Ultra-Precision Machining Technologies”

“Mass Production Technologies”

July, 2001



Vertically Integrated Manufacturing System in Bearings Operation

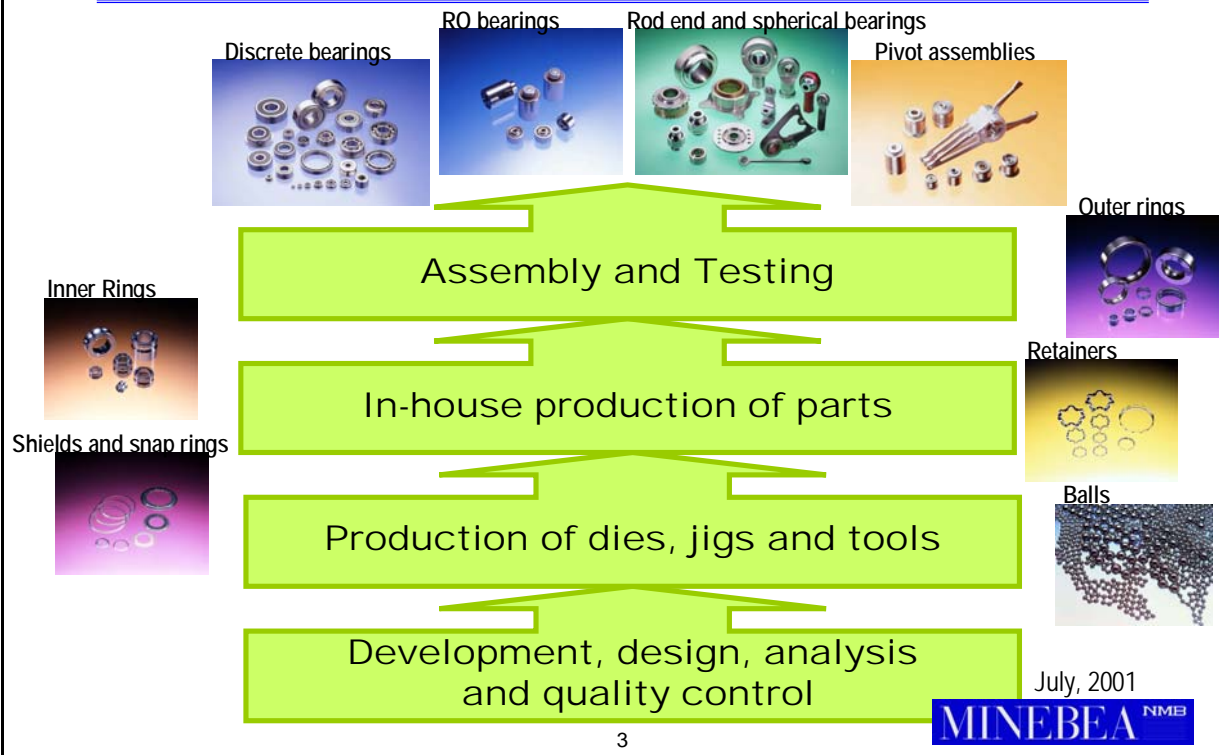

Fluid Dynamic Bearing ~ Cross Section and Components

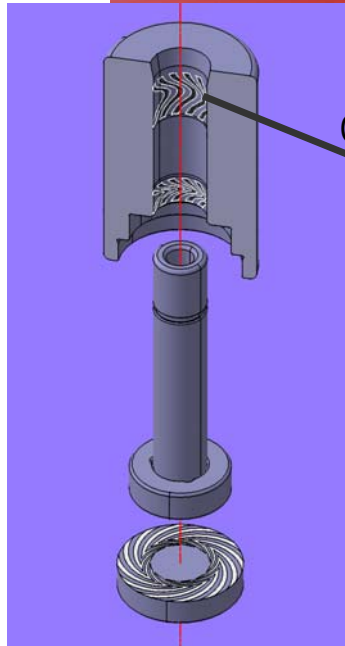

Groove

In a fluid dynamic bearing, the ball function is replaced with a thin layer of lubricant. Special grooves in the metal bearing parts generate a hydrodynamic force that stabilizes the rotation and provides the vibration damping. Minebea's fluid dynamic bearings bring together Seagate Technology's design and development capabilities and Minebea's ultra-precision machining and mass production technologies.



July, 2001

MINEBEA NMB

Minebea Begins Mass-Production of Spindle Motors with High-Precision RO bearings for use in 20GB/Platter Large-Storage Capacity 2.5-inch HDDs

<Extract from Press Release of June 26, 2001>

Minebea has launched mass-production of spindle motors that use high-precision RO bearings for 20GB/Platter large-storage capacity 2.5-inch HDDs.

Combining the functions of two ball bearings in one, RO bearings, which minimize non repeatable run-out (NRRO) and misalignment, have advantages in reliability and rotational accuracy and facilitate more compact design of motors.

2.5-inch HDD spindle motors that Minebea has started mass-production use a new type of RO bearings in that inner ring rigidity, raceway accuracy, ball sphericity, and surface roughness are greatly improved, thereby enhancing reliability, NRRO, and sound level.

RO bearings presently fitted in spindle motors for large-storage capacity 3.5-inch HDDs use ceramic balls made in-house. Minebea is planning to use ceramic balls in RO bearings for use 2.5-inch HDD spindle motors in order to further improve reliability, NRRO, and sound level.

July, 2001



As in our press release of June 26th, we have commenced mass production of spindle motors, using RO bearings, for 2.5-inch HDD with a capacity of 20GB/platter. The important themes of HDD spindle motors are acoustic noise and NRRO (non-repeatable run out).

HDD Spindle Motor Performance Trend

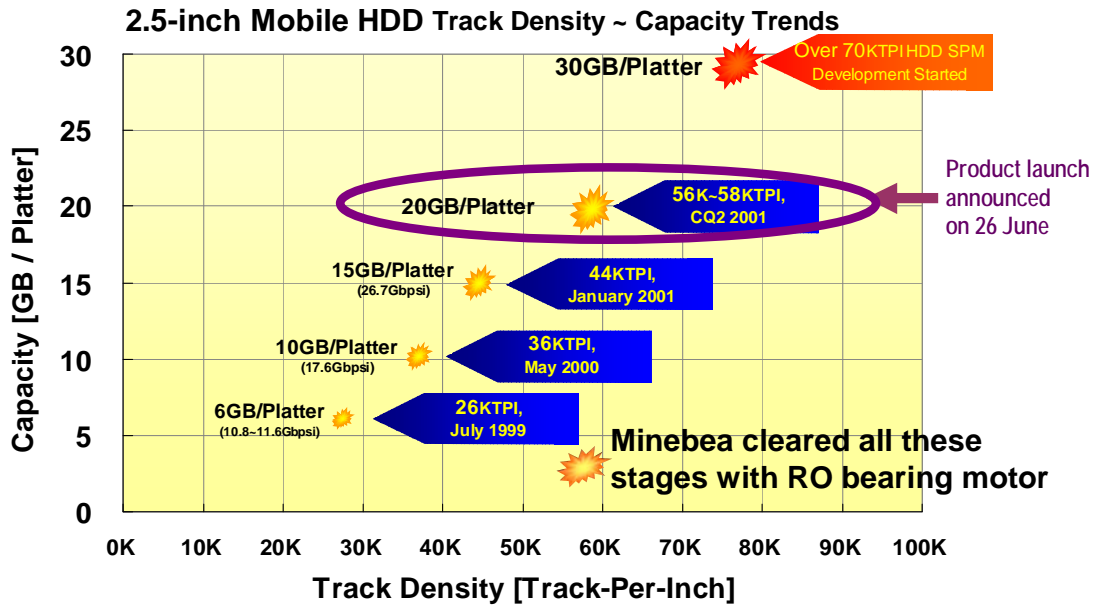

July, 2001



Spindle motors for 2.5-inch HDD with a capacity of 20GB/Platter have a TPI of 56,000 to 58,000 and a noise level of 24 to 26 dB. Comparing to spindle motors using FDB, TPI is the same while noise level is higher by just 2dB, which is virtually indistinguishable, despite the fact that quietness is said to be a feature of FDBs.

Achieving the performance required for 20GB/platter has been made possible only with Minebea's patented RO bearings - the breakthrough has not yet been achieved using discrete bearings, including by competitors. Moreover, we are planning to improve performance further by using ceramic balls in the future 2.5-inch HDD spindle motors. RO bearings presently fitted in spindle motors for 3.5-inch HDDs already use ceramic balls made in-house.

Ball Bearings Production Trend

Annual volume
(bn units)

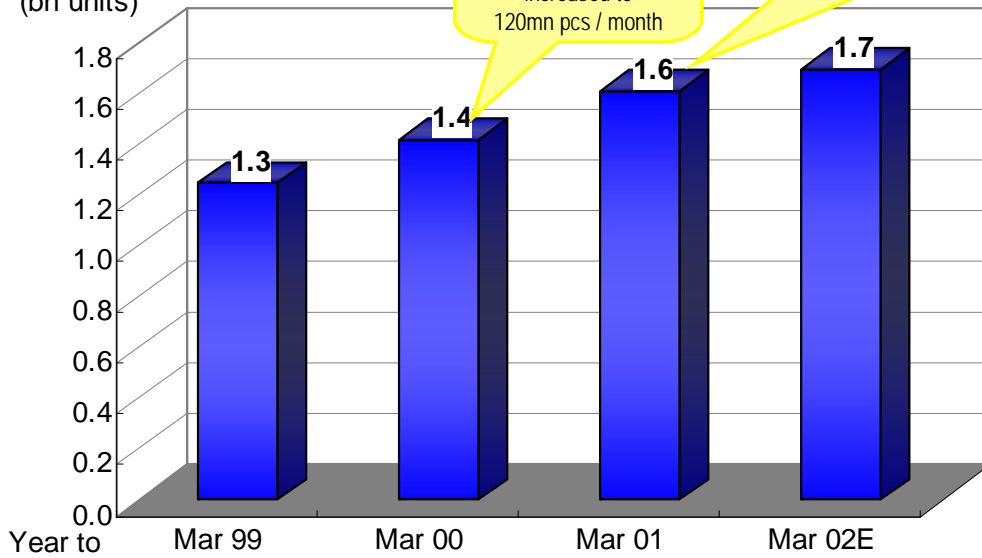

July, 2001



Ball Bearings Sales by Region

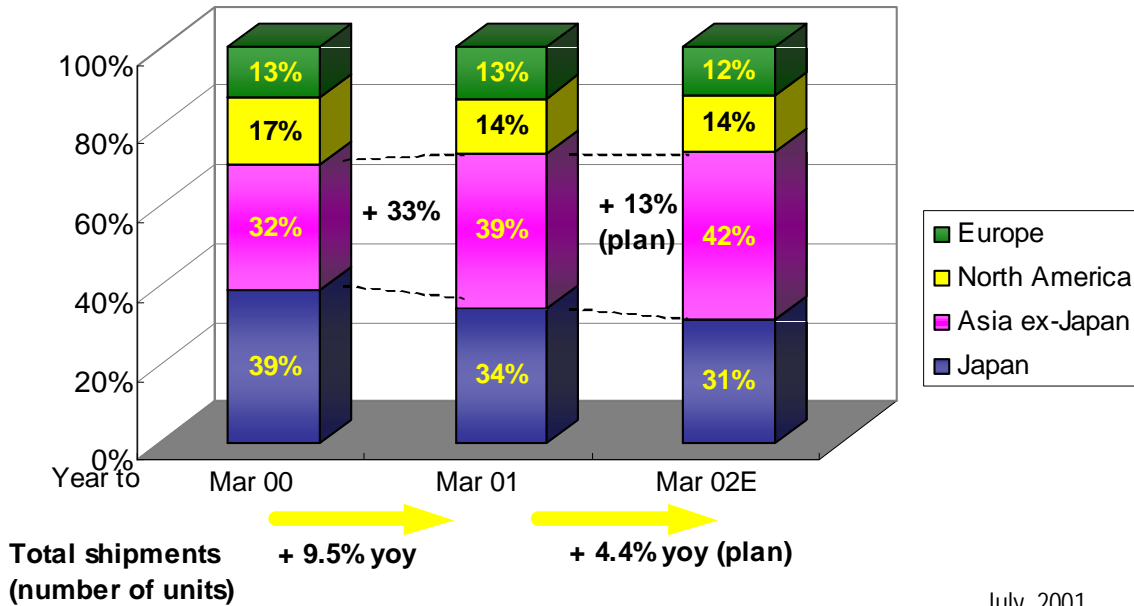

July, 2001

MINEBEA NMB

8

External sales of ball bearings expanded 9.5% year on year, on a volume basis during last fiscal year. We plan a 4.4% increase this year, which partly reflects economic slow down. For sales in Asia region, we forecast a 13% year on year increase this fiscal year, after a 33% growth in the previous year, on the back of robust demand from Chinese home electrical appliance industry, such as air-conditioners and cleaners. Assuming a recovery in PC demand from summer, we expect sales of ball bearings to rise steadily throughout the current fiscal year. As for unit prices, we forecast no decline for each product category in local currency terms, as we witnessed last year.

Ball Bearings for Internal Use

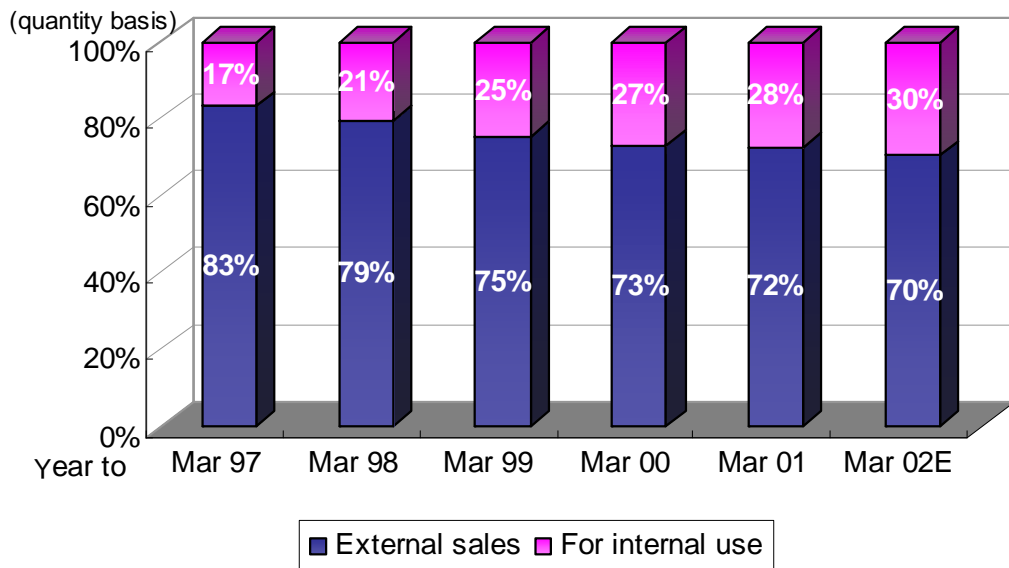

July, 2001

MINEBEA NMB

9

Ball bearings for internal use have risen steadily over the past several years and we expect a several percentage point increase this year.

During April to June quarter, total production volume of ball bearings was between 130 million to 140 million units/month, which is in line with stated plan. Achieving the production target of 1.7 billion units for the full year is dependent on potential PC market recovery. However, ball bearings, which is most profitable product for us, has a diverse customer profile and firm demand growth, hence creating a stable earnings source.

Minebea's HDD Spindle Motor Production Plan

**This year's new models:
Motors for
20GB/platter 2.5-inch HDDs
Servers and high-end 3.5-inch HDDs
1.8-inch HDDs
and
Seagate 3.5-inch HDDs (FDB)**

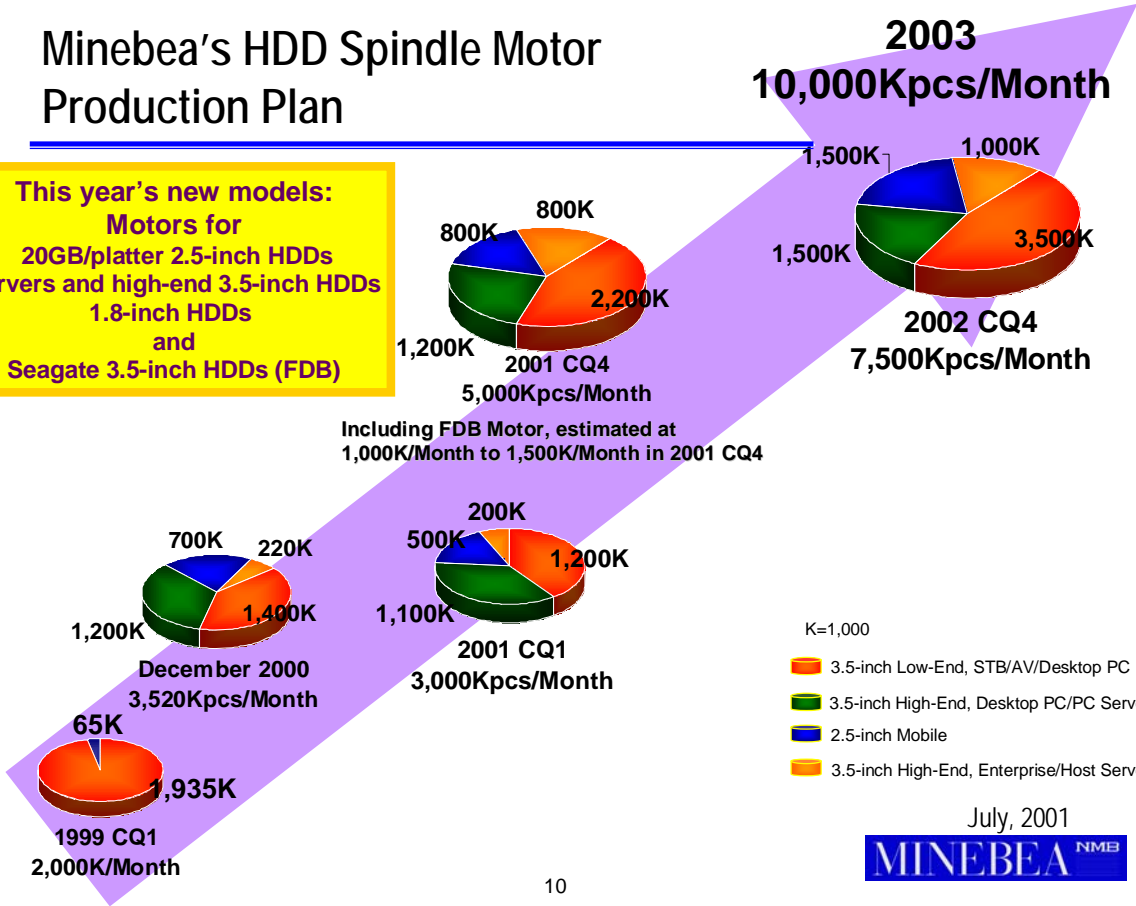

Minebea's Share in the HDD Spindle Motor Market

- Minebea's spindle motors with RO bearings are being selected as the leading choice for high-end HDD models.
- Production of FDB requires very high precision machining technologies.
- Most HDD makers adopt two vendor policy.

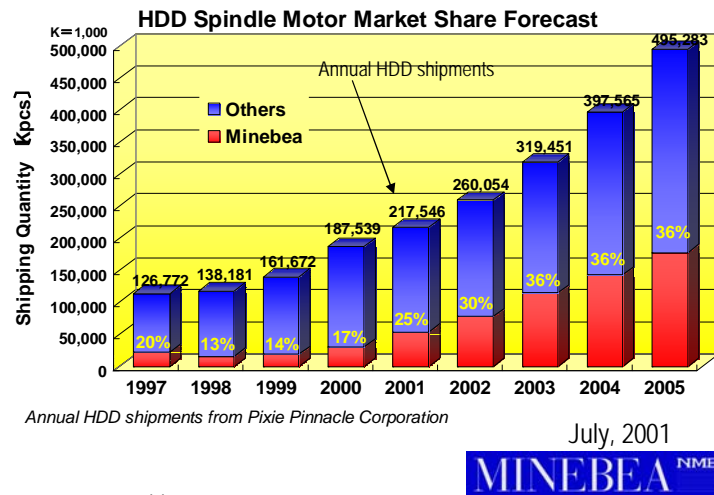

11

Minebea's market share was around 17% last year, however, as shown in this chart, it should climb each year and reach 36% share by 2003, along with the top player, when we plan to produce 10 million units per month. There are three reasons.

1. Spindle motors, using RO bearing, is increasingly more selected as the leading choice in high-end models.
2. By utilising our ultra-precision machining technologies fully, we have an ability to supply highly reliable FDB products consistently.
3. Most HDD makers adopt two vendor policy, therefore requires a supplier that can match the top vendor.

Ball Bearing Motor vs. FDB Motor

- ✓ Reliability
- ✓ Performance - 20GB/platter 2.5-inch HDD (RO Bearings)
- ✓ 1.8-inch or smaller HDDs
- ✓ Load carrying capacity

July, 2001



12

This year indeed signifies the start of FDB business, as implied by the emergence of a number of HDD makers that have announced to employ FDB motors in their mass-produced models. However, there are many who still favour ball bearings. Reasons are

1. PC makers are still generally doubtful of reliability of FDB motors, recalling past and even recent troubles of sudden death.
2. Limit of ball bearings no longer poses a concern after recent launch of 20GB/platter 2.5-inch HDD, which uses our RO bearing.
3. FDB motors have not yet been accepted for the use in next generation 1.8-inch HDD.
4. Even regarding performance under high speed rotation, which is said to be a strong aspect of FDBs, there are some issues. When 3.5-inch HDD with a multiple number of discs is rotated at a high speed, fluttering phenomenon occurs, causing the shaft to vibrate.

Fluid Dynamic Bearings Business

Production Capacity

As of March 2001

500K/month



From April 2001

1,000K/month (K=1,000)

Current Production Volume : May 100K, June 150K, July 350K

Currently, our FDB motor production is for Seagate Technology only.

However, we will be able to start to ship sample products to other HDD makers from November.

Accumulated Capex as of March 2001 : ¥ 5bn

(Machinery and equipment ¥ 2bn; Factory building ¥ 3bn)

Completed a new plant for fluid dynamic bearings and HDD spindle motors in Thailand – has HDD spindle motor production capacity of 6 million units when filled with machinery and equipment.

July, 2001



13

Although ball bearing motors, especially RO bearing motors, currently have many advantages over FDB motors as discussed in the previous slide, we view FDB as a new addition to our bearing product range and we are placing strategic emphasis on FDB business and are making investment including construction of a new plant, which was completed in March, 2001.

Currently, we develop and produce FDBs through strategic partnership with industry leader, Seagate Technology. What we have discovered since the start of mass production is that the quality and performance of FDBs is determined almost entirely by precision of component machining. In other words, FDB brings out the Minebea's strength, ultra-precision machining technologies, and it is an ideal product for us.

Our FDB spindle motor shipments have been gradually increasing, in step with demand at Seagate Technology; May's shipments were 100 thousand units, June 150 thousand units, and we will ship 350 thousand units in July. From November this year, we will be able to start to ship FDB motor samples to HDD makers other than Seagate Technology, and we have received strong interests from many HDD makers.

We believe that over the next two to three years, RO bearing motors and FDB motors will compete and complement each other in the spindle motor market. They have different strengths, which should be applied in appropriate areas. Moreover, in general, FDB technology and production methodology is yet to reach the perfection. In collaboration with Seagate Technology, we are continuing to make improvement in designs, types of materials and production methods so that FDBs would really become the key to the performance of HDDs.

Because we have both RO bearings and FDBs, which both require ultra-precision machining technologies, we believe we could secure a superior position in the spindle motor market.

Rotary Components for Automotive Use



Trend in the automotive industry

- Environmentally friendly
- Safety
- Comfort



*Increasing demand
for high-performance
motors and sensors*

Minebea's rotary components for automotive use

- Motors for EPS (a)
- Dashboard unit motors (b)
- Headlight actuators (c)
- V/R resolvers (d)

July, 2001

MINEBEA NMB

Outlook for Fiscal Year ending March 31, 2002

(billions of yen)	Forecast for Year ending March 2002 (*)	Change yoy	Target in the Three-year management plan
Net sales	300	+ 4.5%	332
Operating income	33	+ 0.1%	39
Ordinary income	25	+1.1%	32
Net income	15	+1.2%	20

** We have assumed 5-8% global PC shipments growth and 16% HDD shipments growth.*

July, 2001



Sales and Operating Income Forecast by Segment

(Ybn)	Year to March 2002						Original target in Three-year plan
	Full year		First Half		Second Half		
	forecast	chg. yoy	forecast	chg. yoy	forecast	chg. yoy	
Sales							
Machined components	124.0	-0.4%	59.0	-3.2%	65.0	2.3%	132.7
Bearing-related products	105.0	3.9%	50.0	1.3%	55.0	6.3%	104.8
Other machinery components	19.0	-18.7%	9.0	-22.5%	10.0	-14.9%	27.9
Electronic devices and components	176.0	15.9%	81.0	7.3%	95.0	24.3%	186.0
Rotary components	90.0	22.3%	40.0	12.3%	50.0	31.7%	91.0
Other electronic devices	86.0	9.8%	41.0	2.9%	45.0	17.0%	95.0
Consumer business and others	-	-	-	-	-	-	13.3
Total	300.0	4.5%	140.0	-1.5%	160.0	10.4%	332.0
Operating Income							
Machined components	23.8	-0.4%	11.27	-6.2%	12.53	5.4%	
Electronic devices and components	9.2	11.4%	3.23	-30.8%	5.97	66.3%	
Consumer business and others	-	-	-	-	-	-	
Total	33.0	0.1%	14.5	-15.6%	18.5	17.1%	39.0

Division	Main products
Bearing-related products	Ball bearings, rod-end and spherical bearings, fluid dynamic bearings, pivot assemblies
Other machinery components	Fasteners, wheels, defense-related special parts
Rotary components	Stepping motors, fan motors, spindle motors
Other electronic devices	PC keyboards, FDD subassemblies, MOD, switching power supplies, speakers
Consumer business and others	Import and sale of furniture (Actus) - the business sold in February 2001

July, 2001

MINEBEA NMB

Our business environment, especially PC market, remains slow. In April to June quarter, demand remained low as in January to March quarter, nevertheless, our plans were met. However, for the full year, we had assumed 5-8% PC world-wide shipments growth, therefore, the extent of recovery in PC demand from August, September to second half will be the key to this year's earnings.

Bearing Related Products Sales

Sales breakdown by product (FY to Mar 01)

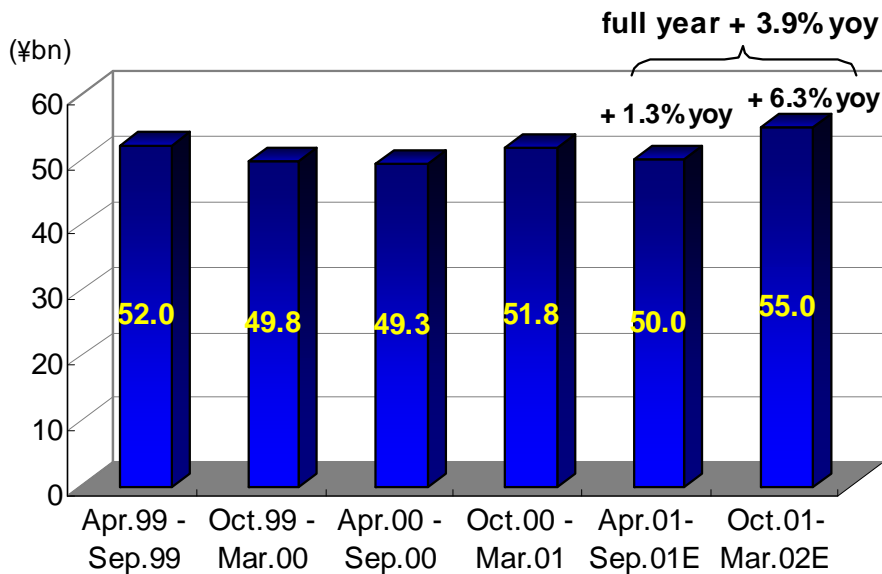
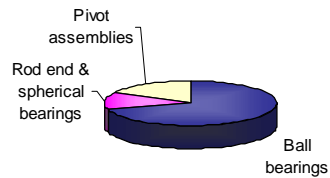

July, 2001



First, regarding bearing related division. I have already mentioned about ball bearings, which constitute 70% of this division's sales. Sales of rod end and spherical bearings is sharply recovering, reflecting upturn of aerospace industry. While, sales of pivot assemblies remain flat despite weak PC market. This is as a result of development and launch of the new low-cost duplex model from last year.

Other Machinery Components Sales

Sales breakdown by product (FY to Mar 01)

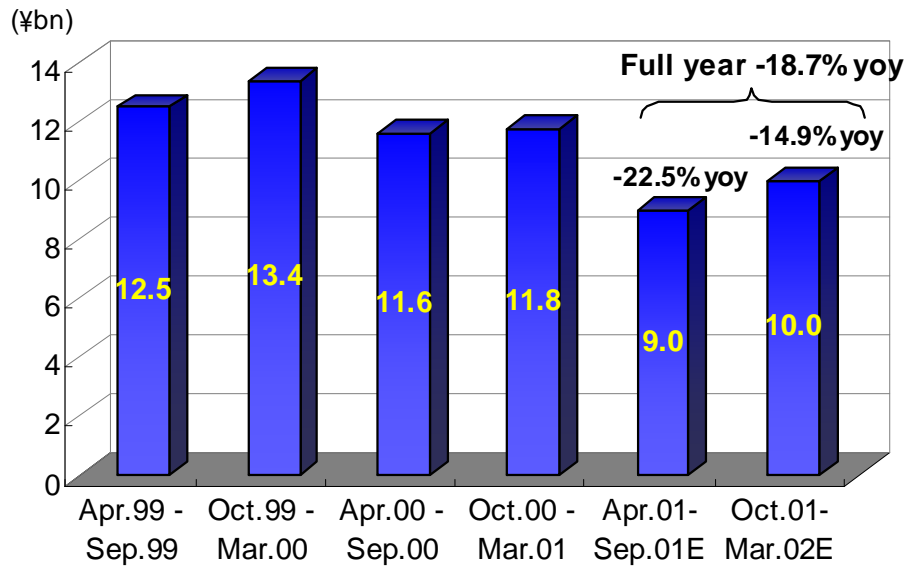
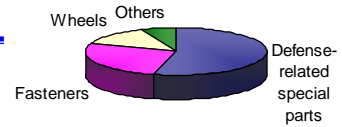

July, 2001



In other machinery components division, restructuring in fastener and wheels business are progressing as planned.

Restructuring Plans in Other Machinery Components Division

➤ **Wheels**

- ✧ Decided to withdraw from business and to close Kyoto plant.
- ✧ Complete exit from the business will be in November.
- ✧ Sales to fall to 1/3 of last year's level.

➤ **Fasteners**

- ✧ Fundamental restructuring of personnel and organizational structure is underway.
- ✧ Product line-up is under review.
- ✧ Aiming to turn profitable next fiscal year.

July, 2001



Rotary Components Sales

Sales breakdown by product (FY to Mar 01)

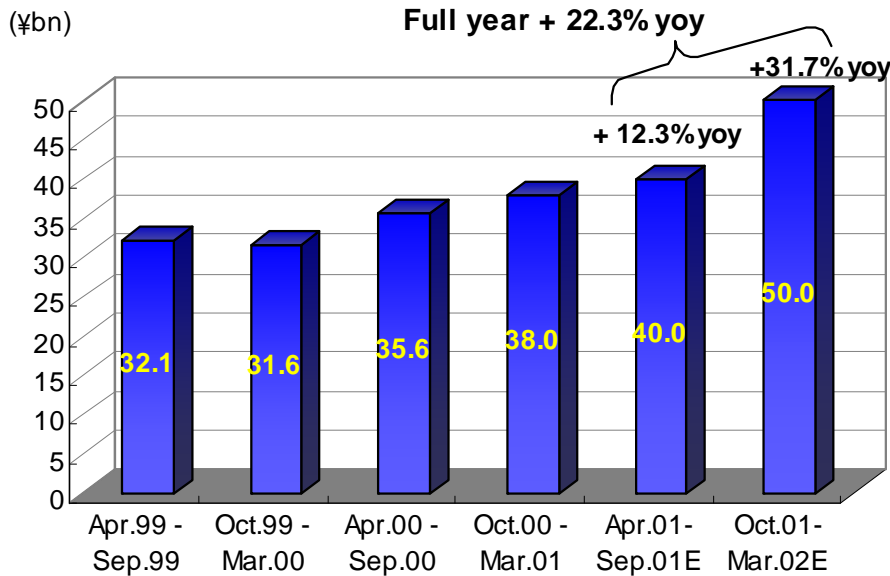
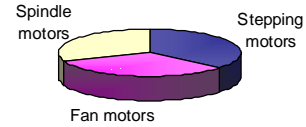

July, 2001



20

In rotary components division, spindle motors and stepping motors sales are firm. By becoming the first choice supplier for new models, we target more than 50% sales growth in spindle motors sales for the full year, the same rate as last year. There have been some delays in launch of new models, however, business is progressing mostly as planned. We plan a 5 to 10% increase in stepping motors and fan motors sales. During recent months, printer market is sluggish however copiers and other OA equipment market remains firm, resulting in steady business of stepping motors. On the other hand, fan motor business is weak due to inventory adjustment in the industry. However in the second half, we look for an end in inventory adjustment, a recovery in PC market and contribution from additional business by having made a new entry into game business such as for Microsoft's X-box and Sony's Playstation2.

Other Electronic Devices Sales

Sales breakdown by product (FY to Mar 01)

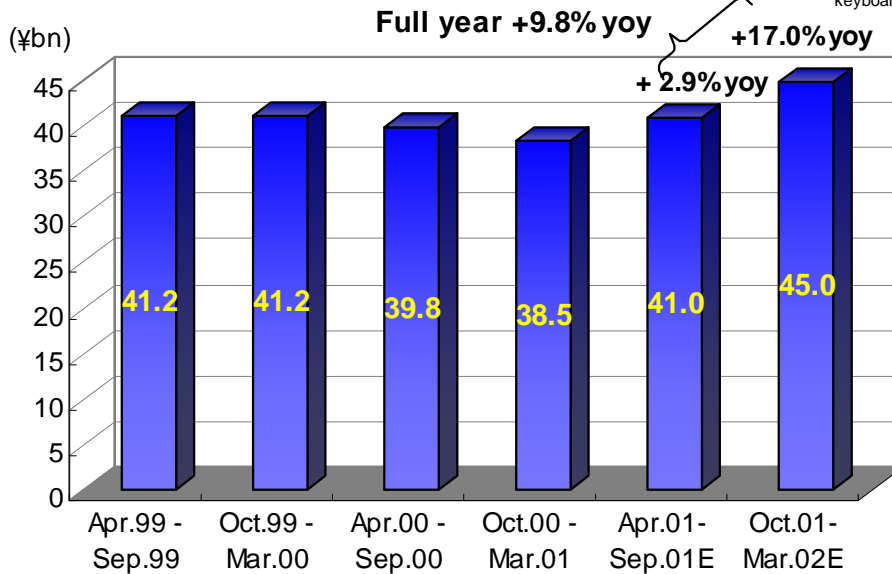
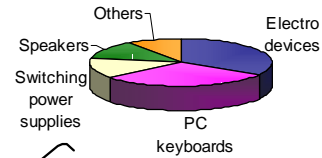

July, 2001



In other electronic devices division, restructuring is progressing as planned in switching power supplies and speaker business, which had been suffering from poor results during the last several years.

Our focus in PC keyboards business is profitability rather than sales growth, following a large sales increase last year. In April to June quarter sales were firm. Within electro device business, we look for sales of FDD to be flat, MOD to fall for the full year. Sales of these products in April to June were as planned. Front light assembly business should contribute from this year. The most important component in front light assembly is the guide plate, which requires micro degree control of reflective angles. This component makes use of our ultra-precision machining process technologies in production of molds for plastic injection molding. Demonstrating our strength, Minebea's front light assemblies have superior performance compared to competitors' and two major mobile hand set makers and one PDA maker are using our product.

This Year's Restructuring Plans in Other Electronic Devices Division

➤ **Switching power supplies**

- ✧ Scaling back and integrating development and manufacturing operations in North America, and development division in Europe.
- ✧ Need to boost sales by at least 30-40%.
- ✧ Aiming to turn profitable on a monthly basis by March 2002.

➤ **Speakers**

- ✧ Transferring manufacturing operation of speaker boxes from Taiwan to Malaysia, the world's center of AV manufacturers.
- ✧ Shifting focus to high-end models.
- ✧ Expect to break-even for the full year.

July, 2001



22

In switching power supplies business, at least a 30 to 40% boost in sales and a shift to high value added products are essential in order to turn the business profitable on a monthly basis. In our plan for this year, we have assumed such a sales increase based on the current order outlook.

In the speaker business, sales target is 20 to 30% increase year on year, in other words, to the sales level of the fiscal year to March 2000.

Incidentally, by making improvement on these four divisions, we are looking for operating profit improvement of around 1 billion yen during the current fiscal year and more than 1 billion yen in next fiscal year.

Operating Income by Segment

Back in line with the three-year management plan

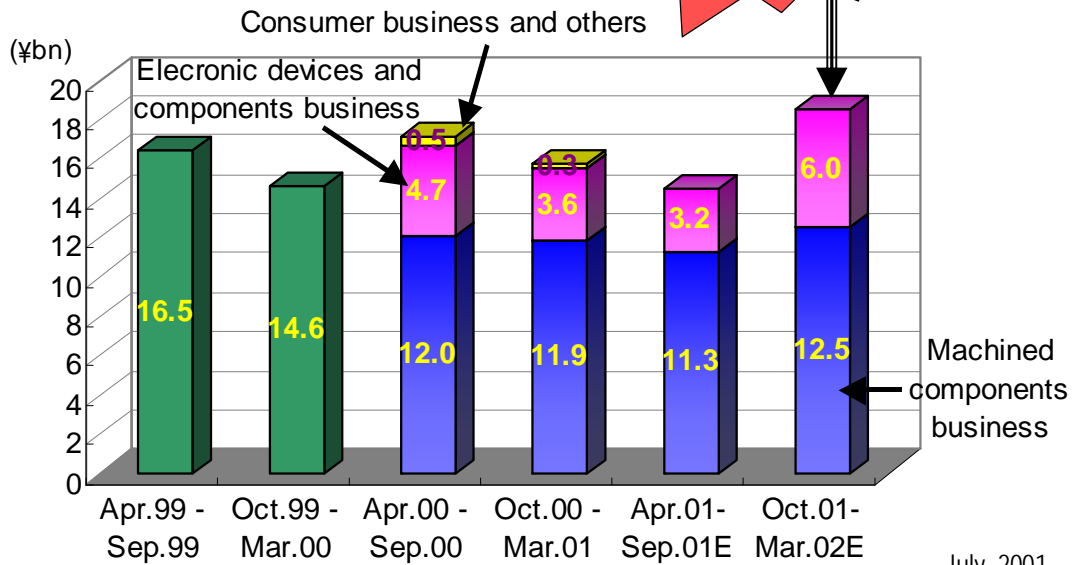

July, 2001



Minebea's Strategy

- Continue to implement and execute restructuring plans in unprofitable business areas.
- Accomplish the three management directions by enhancing:

“Ultra-Precision Machining Technologies”

and **“Mass-Production Technologies”**

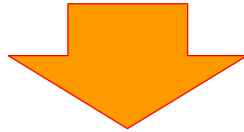

High-Growth, Highly Profitable Company

July, 2001



MINEBEA

Investor Meeting in US

July 2001

Thank you.

Please visit our web site at
<http://www.minebea.co.jp>

July, 2001



Any statements in the presentation which are not an historical fact are future projections made based on certain assumptions and our management's judgment drawn from currently available information.

Please note that actual performance may vary significantly from any particular projection, due to various factors.

Factors affecting our actual performance include: (i) changes in economic indicators surrounding us or demand trends; (ii) fluctuation of foreign exchange rates or interest rates; and (iii) our ability to continue R&D, manufacturing and marketing in a timely manner in the electronics business sector, where technological innovations are rapid and new products are launched continuously. However, this is not a complete list of the factors affecting actual performance.

Copyright Minebea Co., Ltd., and its subsidiaries and affiliates, 2001. All rights reserved.

July, 2001

