



Investor Meeting in US

July 2001

Tsugio Yamamoto

President and Representative Director

Minebea Co., Ltd.

Second Year of the Three-Year Management Plan

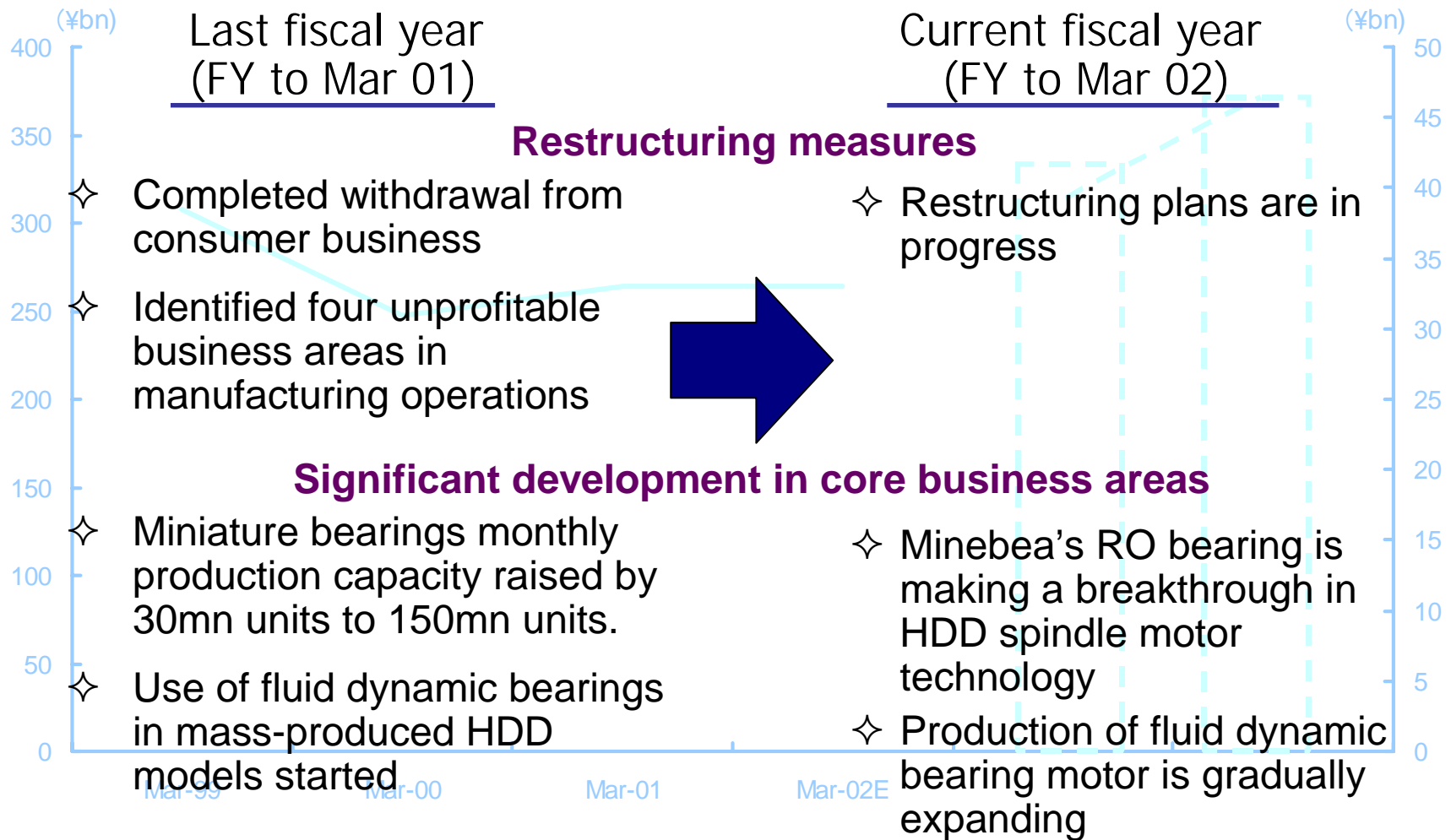

We launched the three-year management plan in May 2000

July, 2001

Three Basic Management Directions to become a High-Growth, Highly Profitable Company

1. To increase production of most profitable mainstay bearings and bearing-related products;
2. To expand small motors and other rotary components business to a scale similar to bearing operation; and
3. To raise the weight of high-value-added products in main product categories.



Realization

Minebea's Basis of Strength

“Ultra-Precision Machining Technologies”

“Mass Production Technologies”

July, 2001

Vertically Integrated Manufacturing System in Bearings Operation

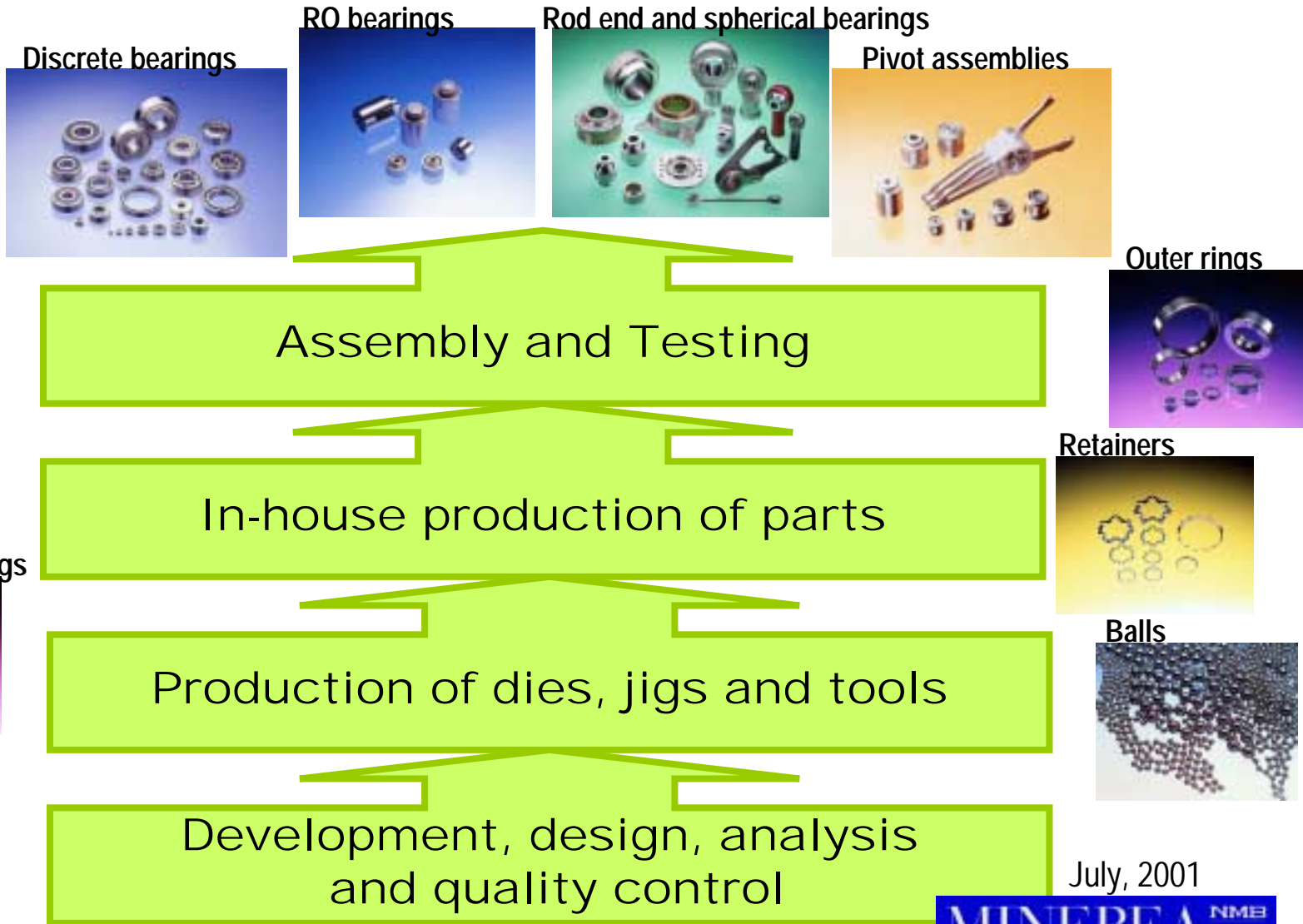

Fluid Dynamic Bearing ~ Cross Section and Components

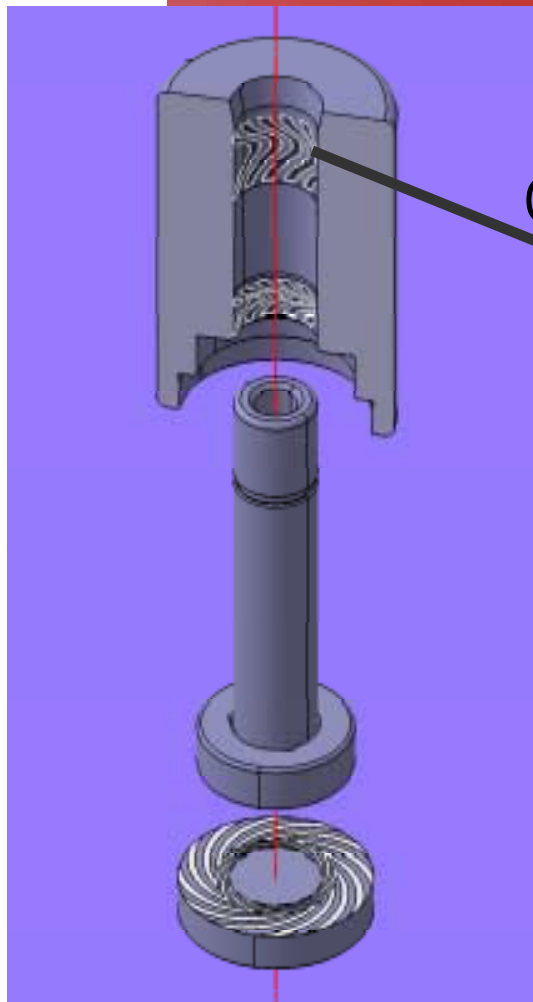

Groove

In a fluid dynamic bearing, the ball function is replaced with a thin layer of lubricant. Special grooves in the metal bearing parts generate a hydrodynamic force that stabilizes the rotation and provides the vibration damping. Minebea's fluid dynamic bearings bring together Seagate Technology's design and development capabilities and Minebea's ultra-precision machining and mass production technologies.



Shaft

Sleeve

Thrustplate

Grooved Counterplate

July, 2001

MINEBEA NMB

Minebea Begins Mass-Production of Spindle Motors with High-Precision RO bearings for use in 20GB/Platter Large-Storage Capacity 2.5-inch HDDs

<Extract from Press Release of June 26, 2001 >

Minebea has launched mass-production of spindle motors that use high-precision RO bearings for 20GB/Platter large-storage capacity 2.5-inch HDDs.

Combining the functions of two ball bearings in one, RO bearings, which minimize non repeatable run-out (NRRO) and misalignment, have advantages in reliability and rotational accuracy and facilitate more compact design of motors.

2.5-inch HDD spindle motors that Minebea has started mass-production use a new type of RO bearings in that inner ring rigidity, raceway accuracy, ball sphericity, and surface roughness are greatly improved, thereby enhancing reliability, NRRO, and sound level.

RO bearings presently fitted in spindle motors for large-storage capacity 3.5-inch HDDs use ceramic balls made in-house. Minebea is planning to use ceramic balls in RO bearings for use 2.5-inch HDD spindle motors in order to further improve reliability, NRRO, and sound level.

July, 2001

HDD Spindle Motor Performance Trend

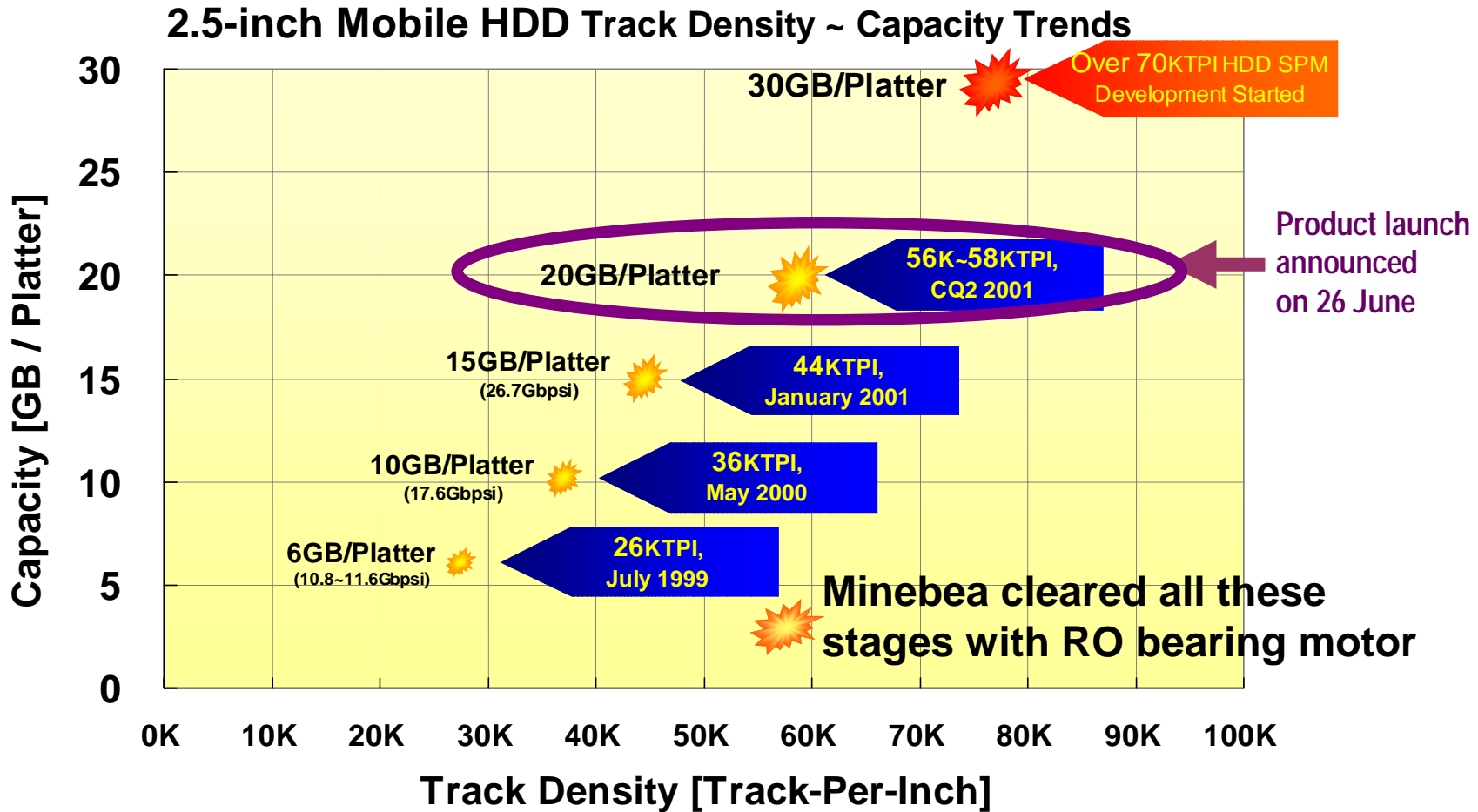

July, 2001



Ball Bearings Production Trend

Annual volume
(bn units)

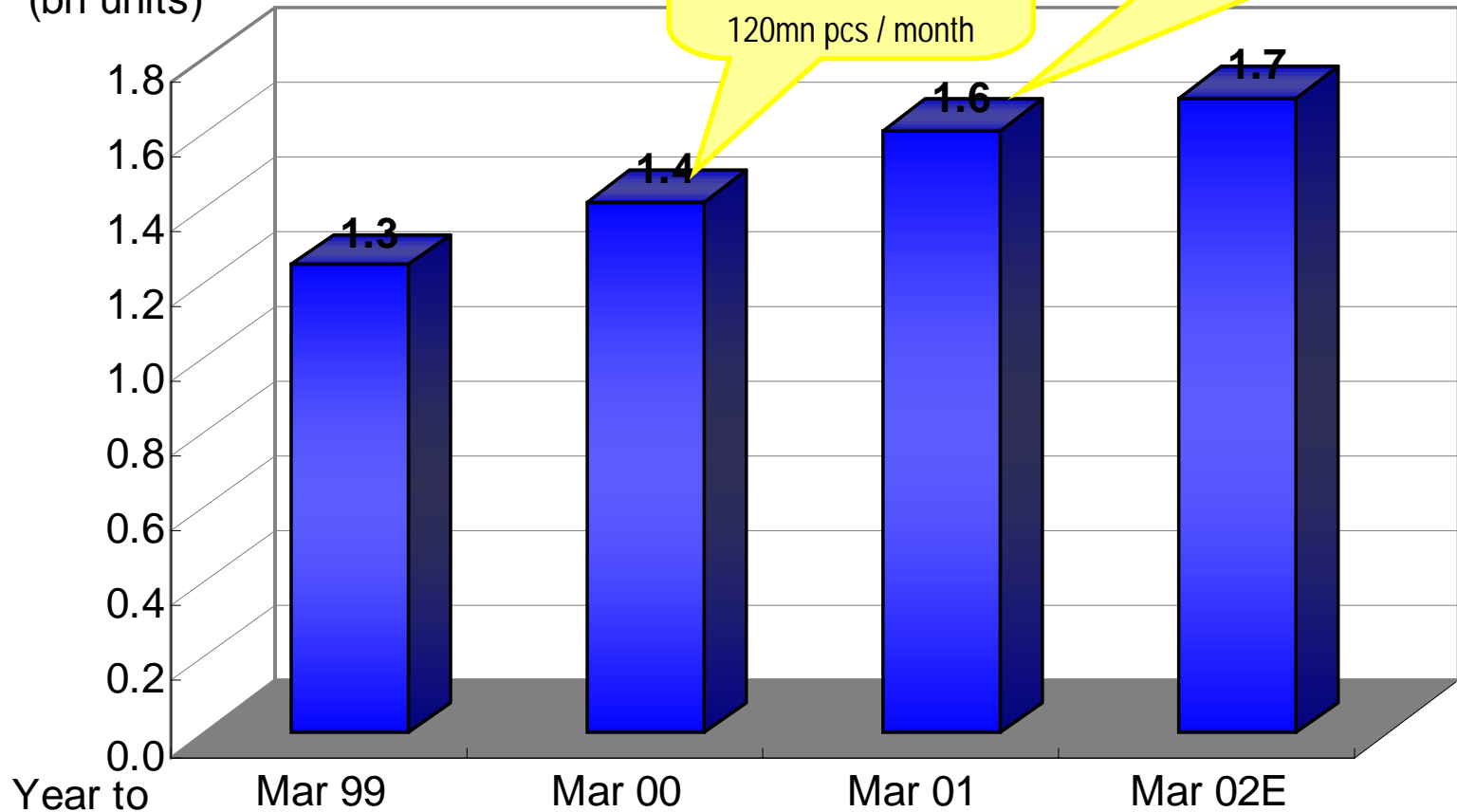

July, 2001

Ball Bearings Sales by Region

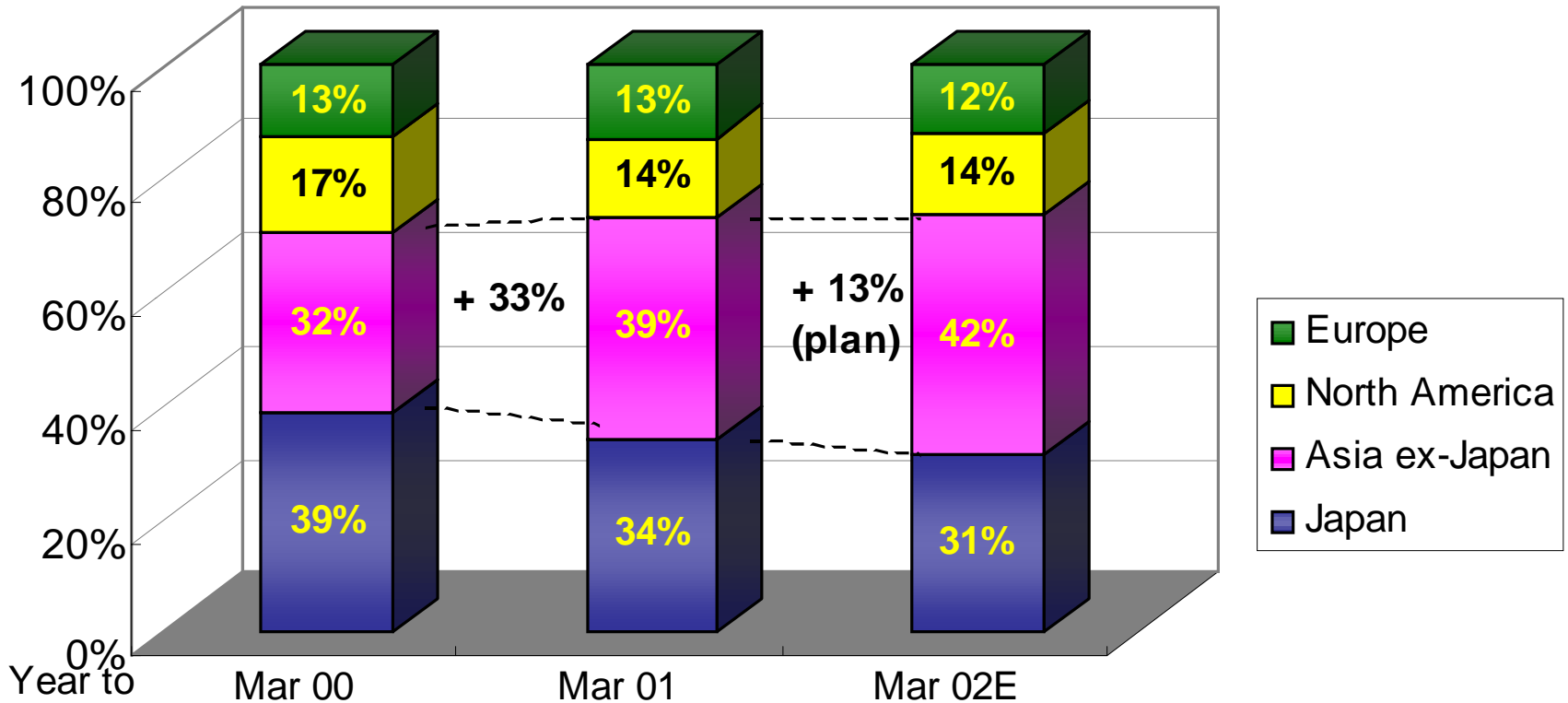

**Total shipments
(number of units)**

+ 9.5% yoy

+ 4.4% yoy (plan)

July, 2001

Ball Bearings for Internal Use

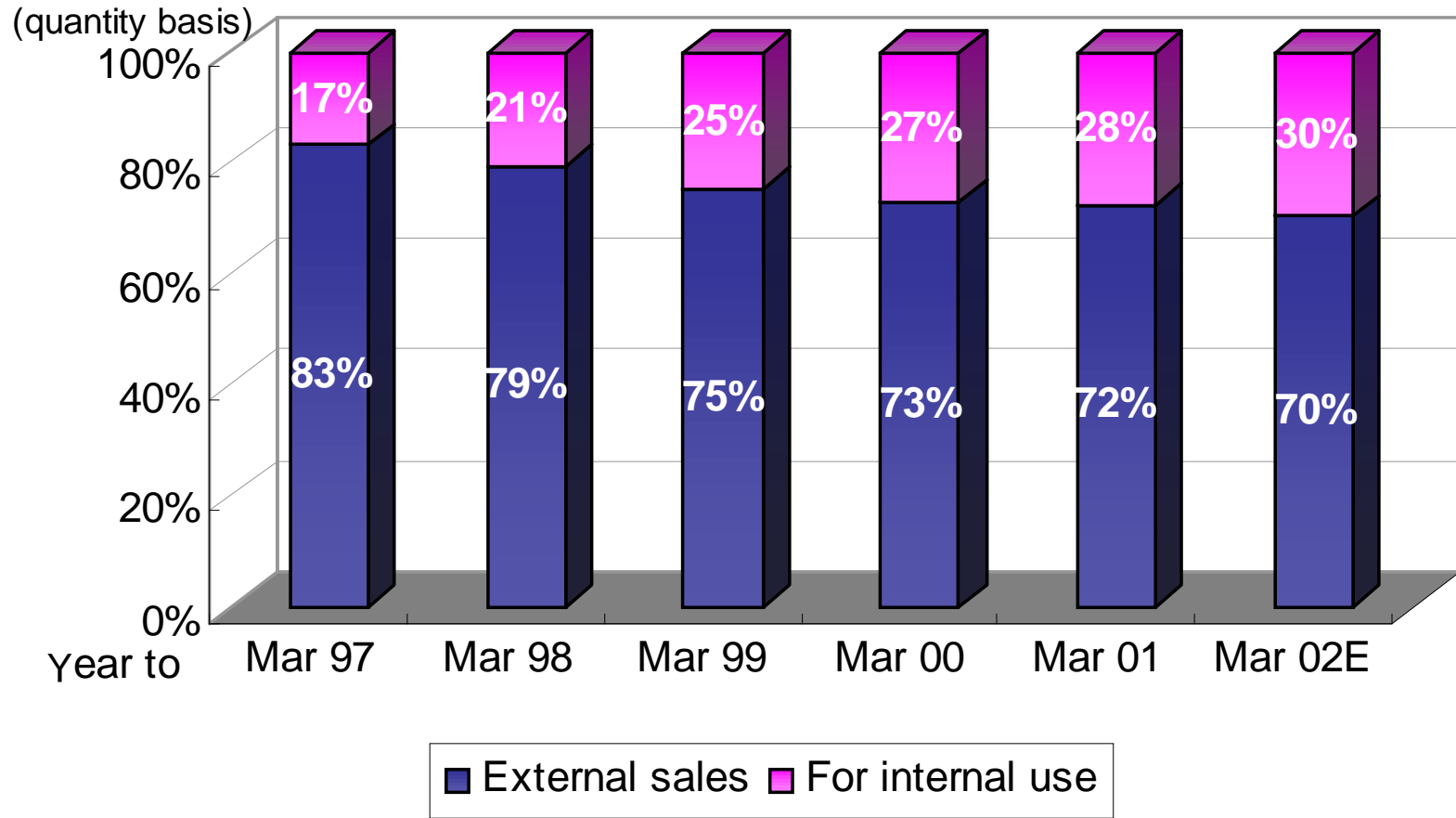

July, 2001

Minebea's HDD Spindle Motor Production Plan

This year's new models:
Motors for
 20GB/platter 2.5-inch HDDs
 Servers and high-end 3.5-inch HDDs
 1.8-inch HDDs
 and
 Seagate 3.5-inch HDDs (FDB)

2003
10,000Kpcs/Month

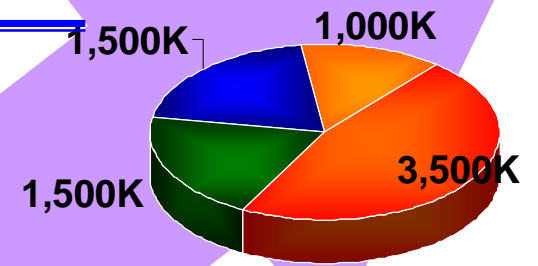

2002 CQ4
7,500Kpcs/Month

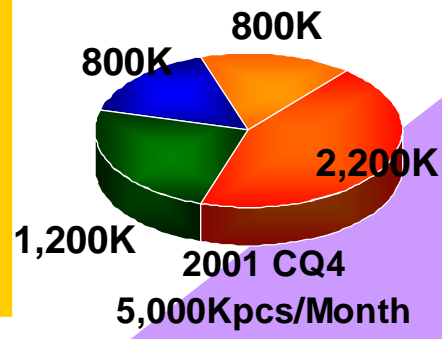

Including FDB Motor, estimated at
 1,000K/Month to 1,500K/Month in 2001 CQ4

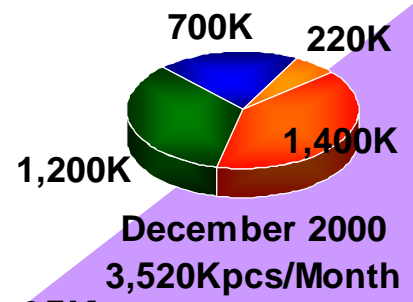

December 2000
3,520Kpcs/Month

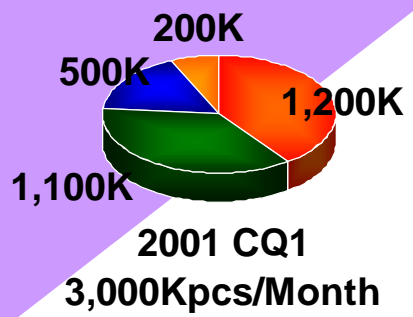

2001 CQ1
3,000Kpcs/Month

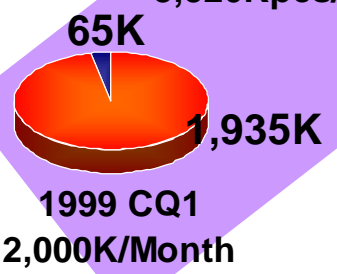

1999 CQ1
2,000K/Month

- K=1,000
- 3.5-inch Low-End, STB/AV/Desktop PC
 - 3.5-inch High-End, Desktop PC/PC Server
 - 2.5-inch Mobile
 - 3.5-inch High-End, Enterprise/Host Server

July, 2001



Minebea's Share in the HDD Spindle Motor Market

- Minebea's spindle motors with RO bearings are being selected as the leading choice for high-end HDD models.
- Production of FDB requires very high precision machining technologies.
- Most HDD makers adopt two vendor policy.

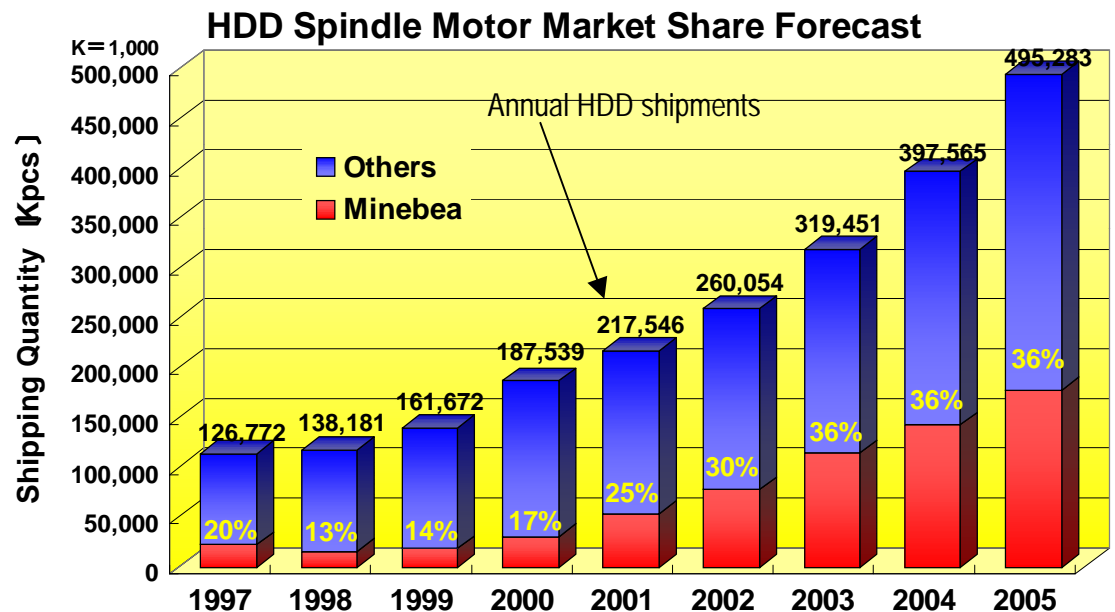

Annual HDD shipments from Pixie Pinnacle Corporation

July, 2001



Ball Bearing Motor vs. FDB Motor

- ✓ Reliability
- ✓ Performance - 20GB/platter 2.5-inch HDD (RO Bearings)
- ✓ 1.8-inch or smaller HDDs
- ✓ Load carrying capacity

July, 2001

Fluid Dynamic Bearings Business

Production Capacity

As of March 2001

500K/month

From April 2001

1,000K/month (K=1,000)



Current Production Volume : May 100K, June 150K, July 350K

Currently, our FDB motor production is for Seagate Technology only. However, we will be able to start to ship sample products to other HDD makers from November.

Accumulated Capex as of March 2001 : ¥ 5bn

(Machinery and equipment ¥ 2bn; Factory building ¥ 3bn)

Completed a new plant for fluid dynamic bearings and HDD spindle motors in Thailand – has HDD spindle motor production capacity of 6 million units when filled with machinery and equipment.

July, 2001

Rotary Components for Automotive Use



Trend in the automotive industry

- Environmentally friendly
- Safety
- Comfort



Increasing demand for high-performance motors and sensors

Minebea's rotary components for automotive use

- Motors for EPS (a)
- Dashboard unit motors (b)
- Headlight actuators (c)
- V/R resolvers (d)

July, 2001

Outlook for Fiscal Year ending March 31, 2002

| (billions of yen) | Forecast for Year ending March 2002 (*) | Change yoy | Target in the Three-year management plan |
|-------------------|---|---------------|---|
| Net sales | 300 | + 4.5% | 332 |
| Operating income | 33 | + 0.1% | 39 |
| Ordinary income | 25 | +1.1% | 32 |
| Net income | 15 | +1.2% | 20 |

** We have assumed 5-8% global PC shipments growth and 16% HDD shipments growth.*

July, 2001



Sales and Operating Income Forecast by Segment

| (Ybn) | -----Year to March 2002----- | | | | | | Original target in Three-year plan |
|--|------------------------------|--------------|--------------|---------------|--------------|--------------|---------------------------------------|
| | Full year | | First Half | | Second Half | | |
| | forecast | chg. yoy | forecast | chg. yoy | forecast | chg. yoy | |
| Sales | | | | | | | |
| Machined components | 124.0 | -0.4% | 59.0 | -3.2% | 65.0 | 2.3% | 132.7 |
| Bearing-related products | 105.0 | 3.9% | 50.0 | 1.3% | 55.0 | 6.3% | 104.8 |
| Other machinery components | 19.0 | -18.7% | 9.0 | -22.5% | 10.0 | -14.9% | 27.9 |
| Electronic devices and components | 176.0 | 15.9% | 81.0 | 7.3% | 95.0 | 24.3% | 186.0 |
| Rotary components | 90.0 | 22.3% | 40.0 | 12.3% | 50.0 | 31.7% | 91.0 |
| Other electronic devices | 86.0 | 9.8% | 41.0 | 2.9% | 45.0 | 17.0% | 95.0 |
| Consumer business and others | - | - | - | - | - | - | 13.3 |
| Total | 300.0 | 4.5% | 140.0 | -1.5% | 160.0 | 10.4% | 332.0 |
| Operating Income | | | | | | | |
| Machined components | 23.8 | -0.4% | 11.27 | -6.2% | 12.53 | 5.4% | |
| Electronic devices and components | 9.2 | 11.4% | 3.23 | -30.8% | 5.97 | 66.3% | |
| Consumer business and others | - | - | - | - | - | - | |
| Total | 33.0 | 0.1% | 14.5 | -15.6% | 18.5 | 17.1% | 39.0 |

| Division | Main products |
|------------------------------|---|
| Bearing-related products | Ball bearings, rod-end and spherical bearings, fluid dynamic bearings, pivot assemblies |
| Other machinery components | Fasteners, wheels, defense-related special parts |
| Rotary components | Stepping motors, fan motors, spindle motors |
| Other electronic devices | PC keyboards, FDD subassemblies, MOD, switching power supplies, speakers |
| Consumer business and others | Import and sale of furniture (Actus) - the business sold in February 2001 |

July, 2001



Bearing Related Products Sales

Sales breakdown by product (FY to Mar 01)

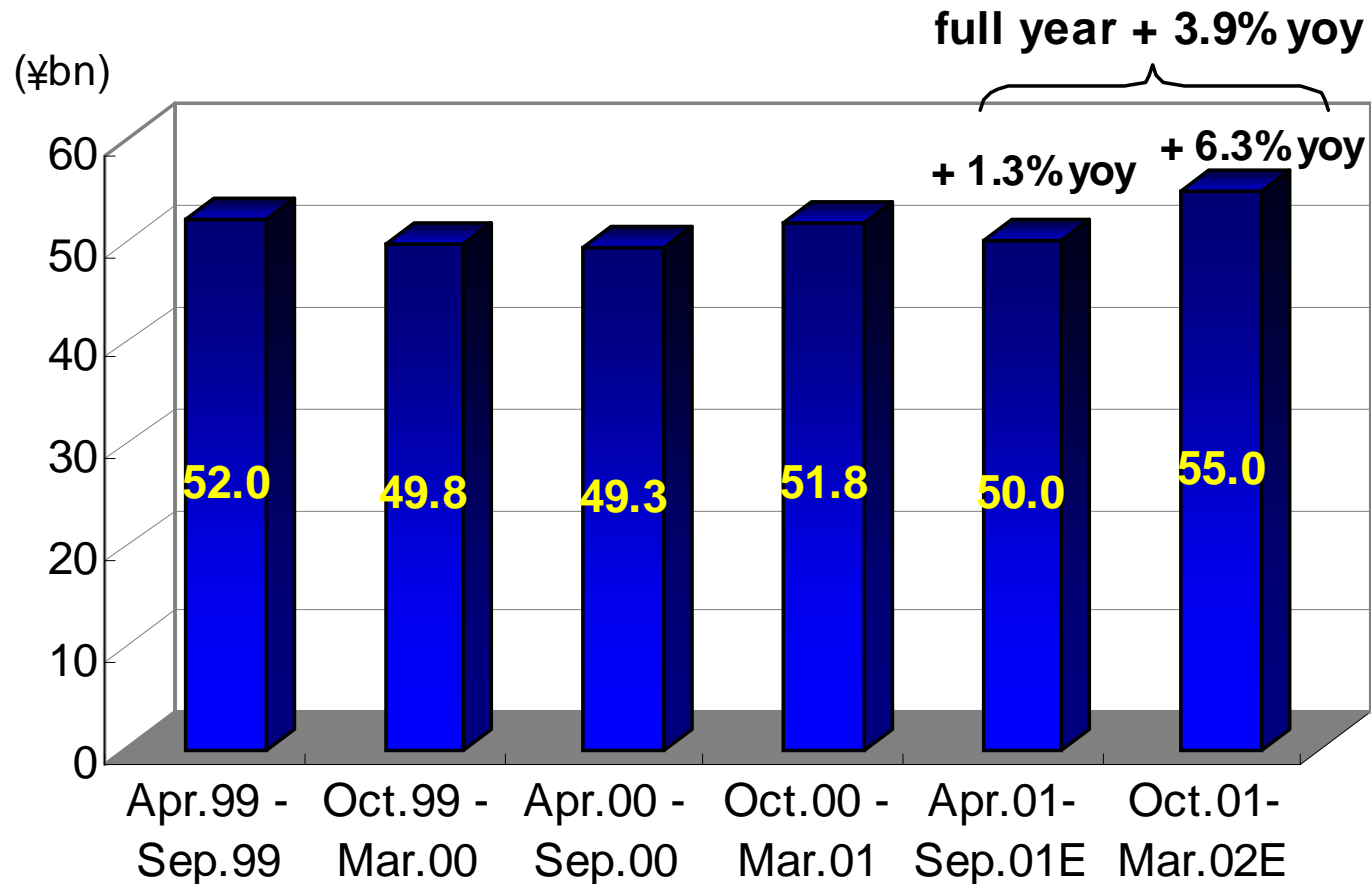
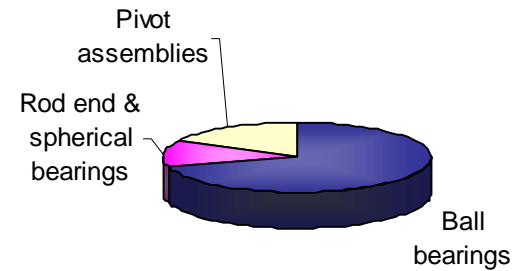

July, 2001



Other Machinery Components Sales

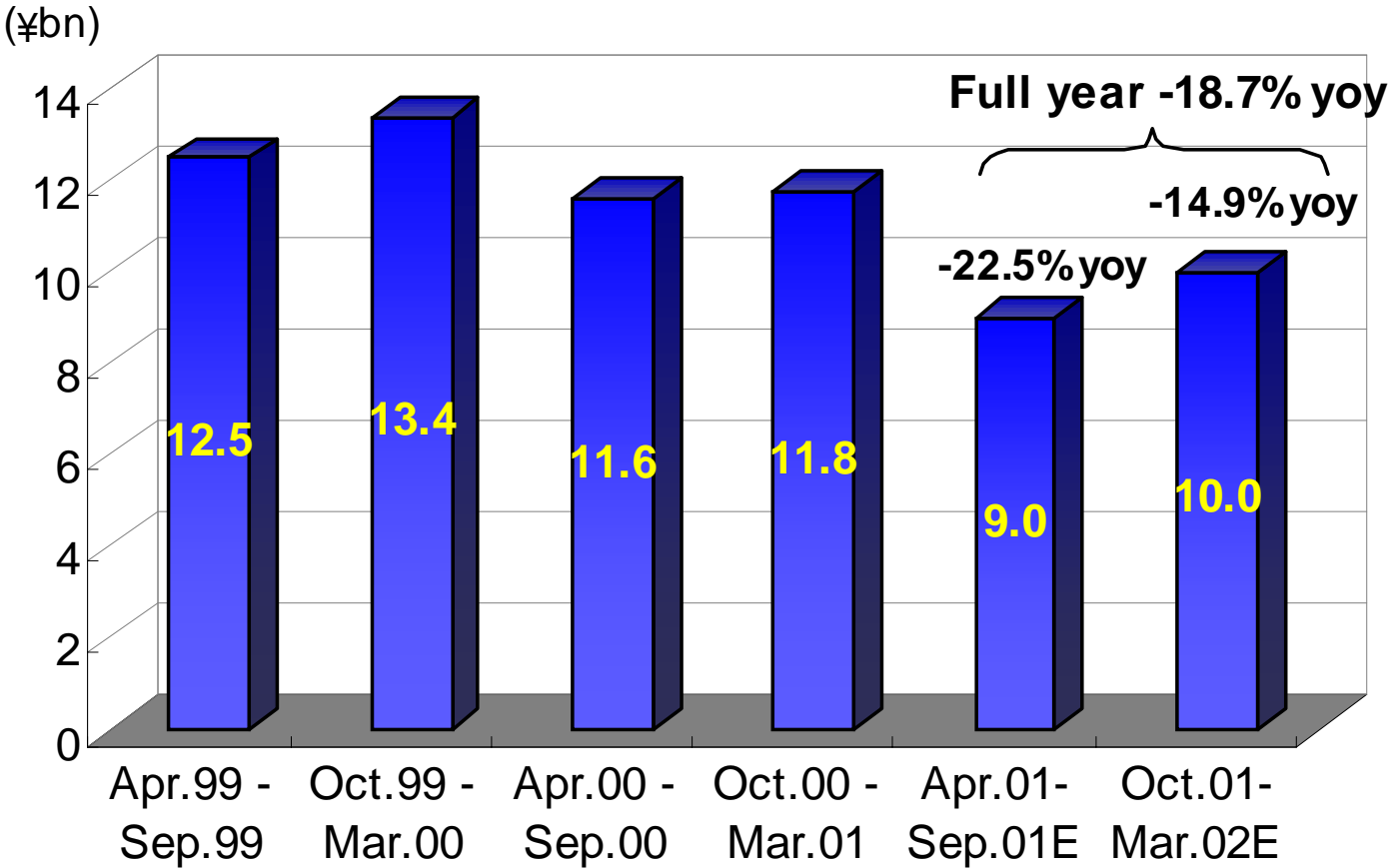

July, 2001



Restructuring Plans in Other Machinery Components Division

➤ **Wheels**

- ✧ Decided to withdraw from business and to close Kyoto plant.
- ✧ Complete exit from the business will be in November.
- ✧ Sales to fall to 1/3 of last year's level.

➤ **Fasteners**

- ✧ Fundamental restructuring of personnel and organizational structure is underway.
- ✧ Product line-up is under review.
- ✧ Aiming to turn profitable next fiscal year.

July, 2001

Rotary Components Sales

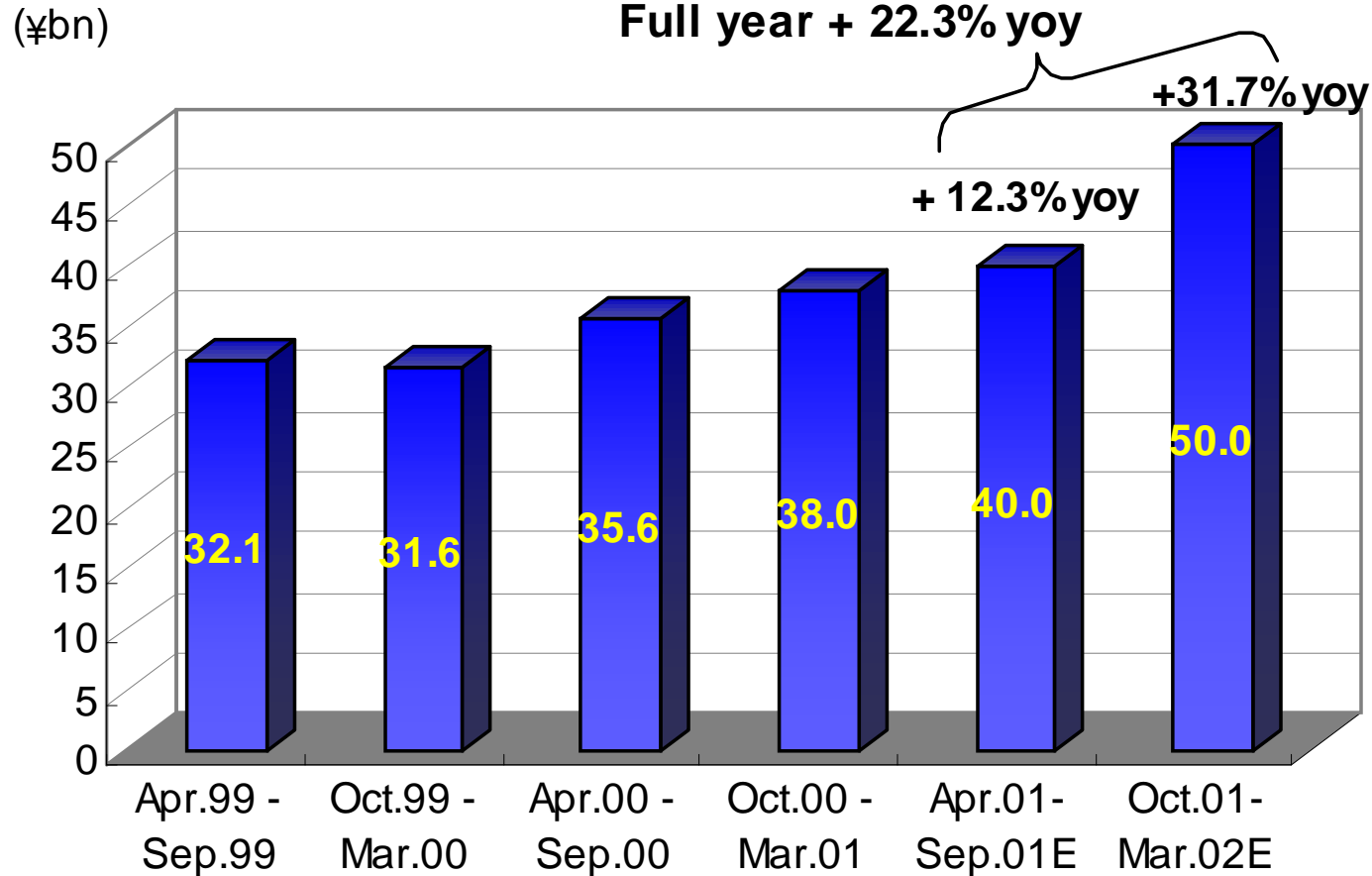
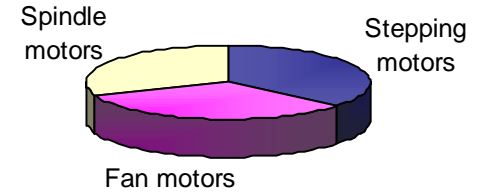

July, 2001

Other Electronic Devices Sales

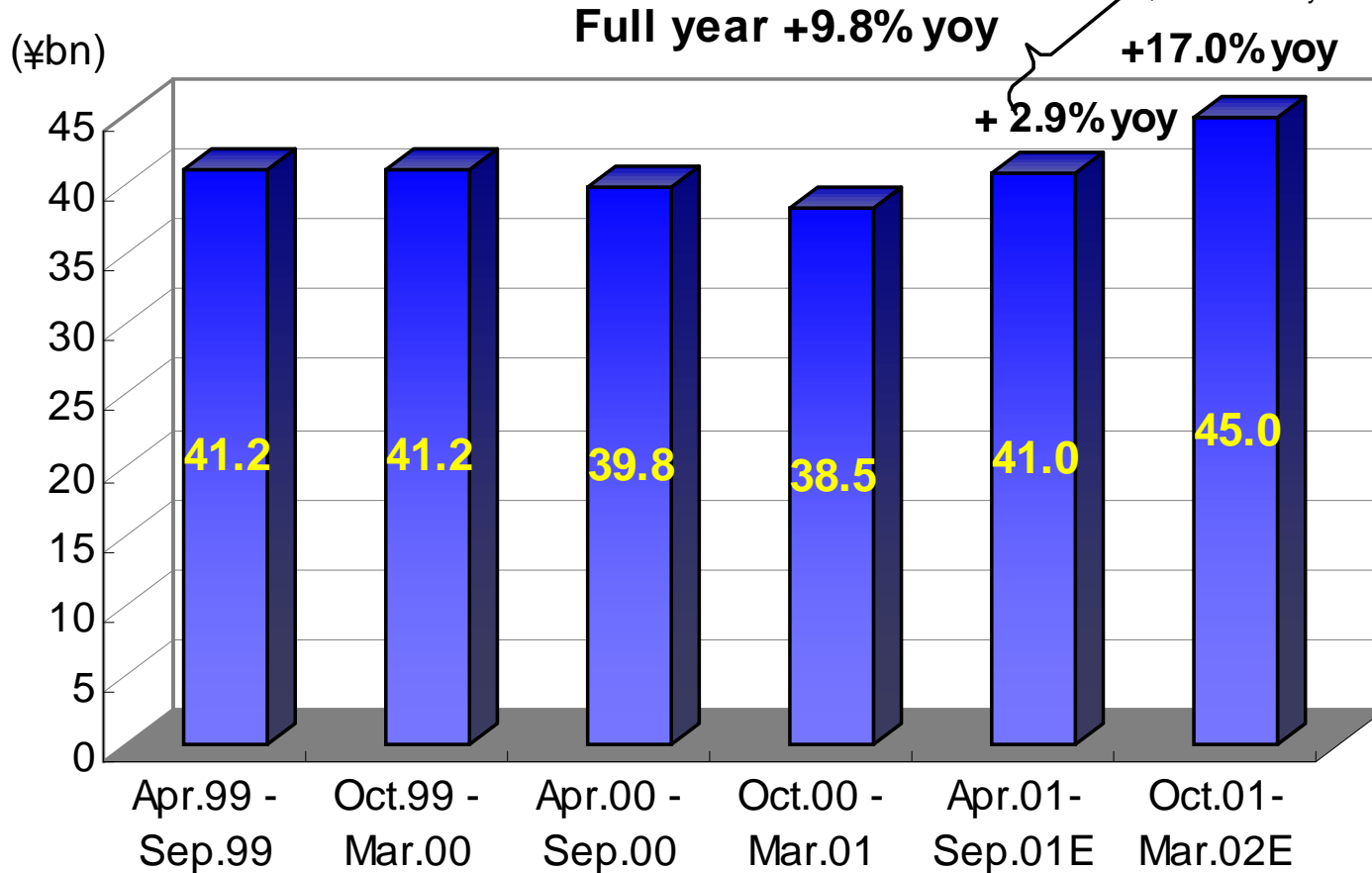
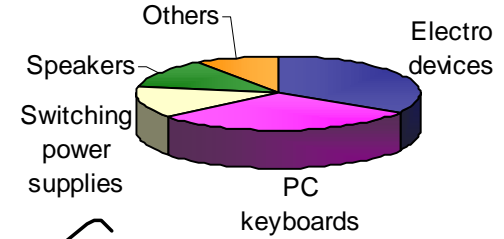

July, 2001

This Year's Restructuring Plans in Other Electronic Devices Division

➤ **Switching power supplies**

- ✧ Scaling back and integrating development and manufacturing operations in North America, and development division in Europe.
- ✧ Need to boost sales by at least 30-40%.
- ✧ Aiming to turn profitable on a monthly basis by March 2002.

➤ **Speakers**

- ✧ Transferring manufacturing operation of speaker boxes from Taiwan to Malaysia, the world's center of AV manufacturers.
- ✧ Shifting focus to high-end models.
- ✧ Expect to break-even for the full year.

July, 2001

Operating Income by Segment

Back in line with the three-year management plan

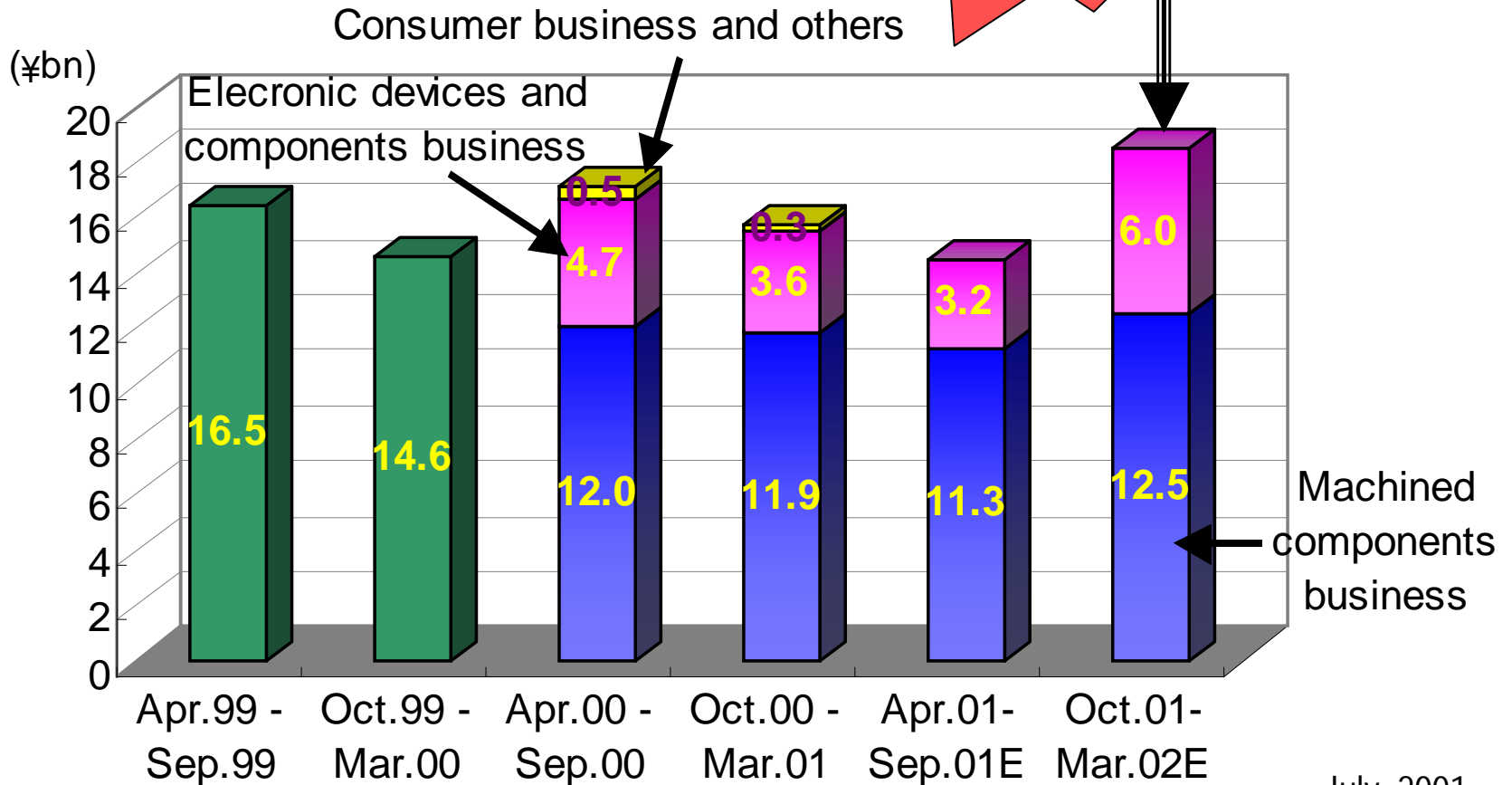

July, 2001



Minebea's Strategy

- Continue to implement and execute restructuring plans in unprofitable business areas.
- Accomplish the three management directions by enhancing:

“Ultra-Precision Machining Technologies”
and **“Mass-Production Technologies”**

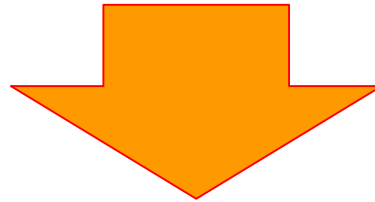

High-Growth, Highly Profitable Company

July, 2001



MINEBEA

Investor Meeting in US

July 2001

Thank you.

Please visit our web site at
<http://www.minebea.co.jp>

July, 2001



Any statements in the presentation which are not an historical fact are future projections made based on certain assumptions and our management's judgment drawn from currently available information.

Please note that actual performance may vary significantly from any particular projection, due to various factors.

Factors affecting our actual performance include: (i) changes in economic indicators surrounding us or demand trends; (ii) fluctuation of foreign exchange rates or interest rates; and (iii) our ability to continue R&D, manufacturing and marketing in a timely manner in the electronics business sector, where technological innovations are rapid and new products are launched continuously. However, this is not a complete list of the factors affecting actual performance.

Copyright Minebea Co., Ltd., and its subsidiaries and affiliates, 2001. All rights reserved.

July, 2001

